

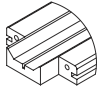

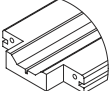









O CIE NICA DO KASETY 100,125mm POJEDYNCZA, PODWÓJNA



 100 mm	 125 mm	 100 mm	 125 mm	 100 mm	 125 mm	
 3,5x25						



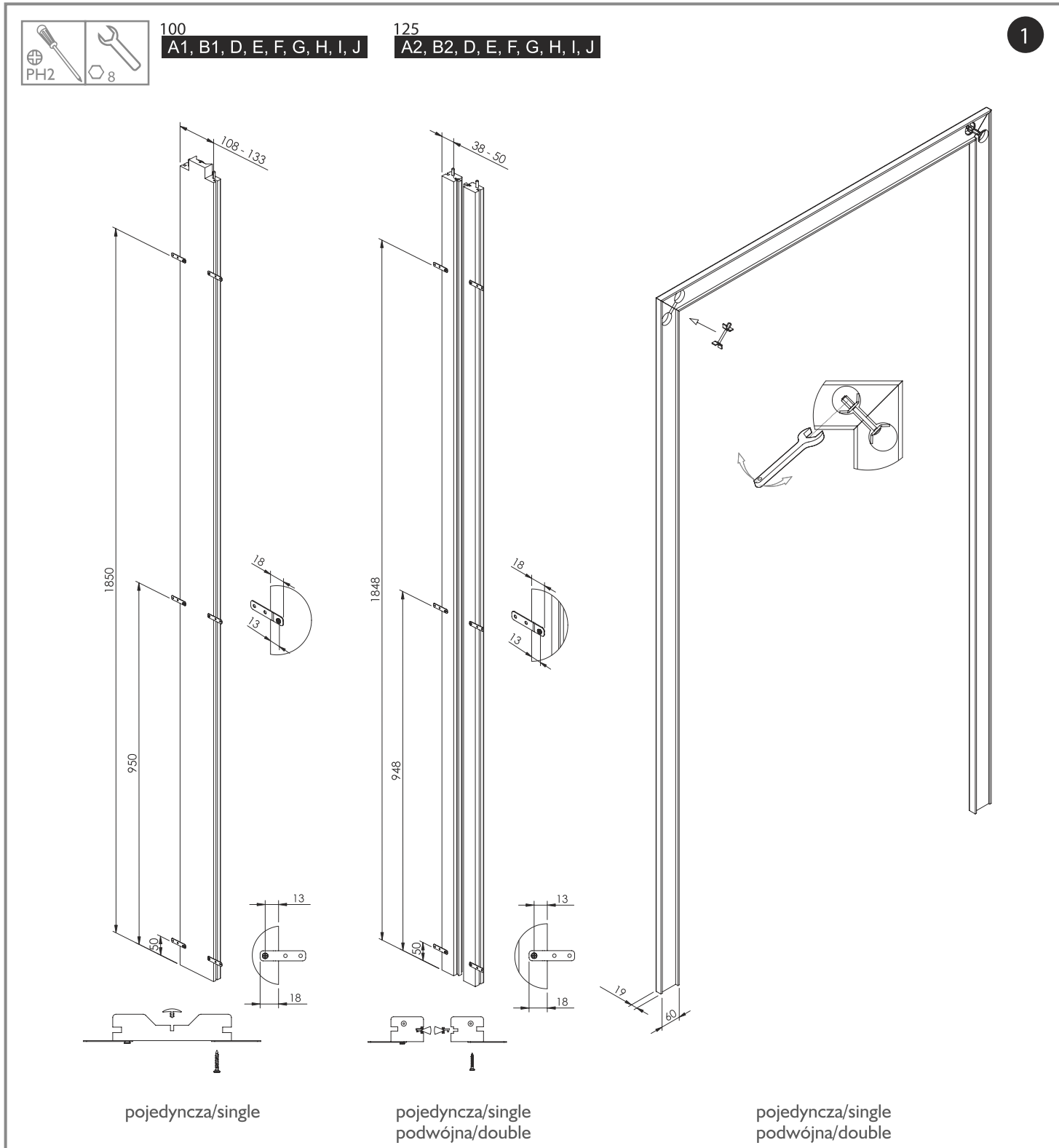
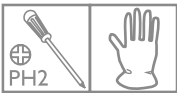

O cie nica pojedyncza 100, 125
Do sztywnego zamontowania u y pianki monta owej nie rozpr nej

2.1

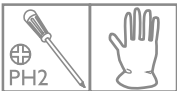
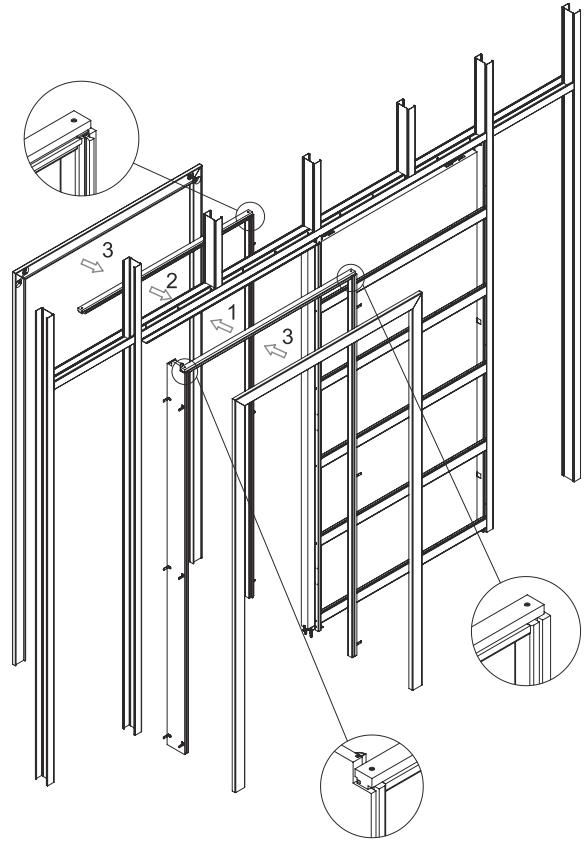
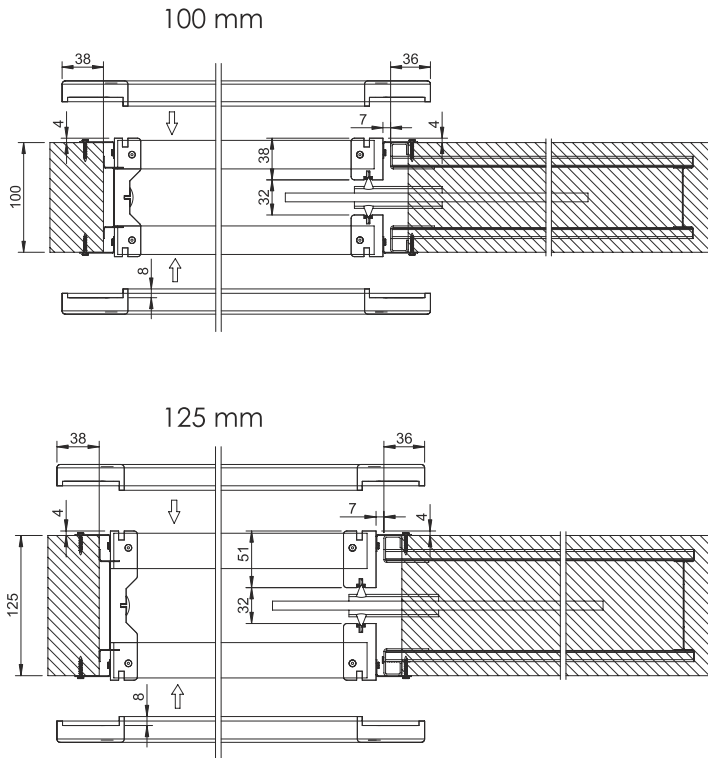

O cie nica podwójna 100, 125
Do sztywnego zamontowania u y pianki monta owej nie rozpr nej

2.2

